



Installation and Operating Instructions

Zevelution 1000S/1500S/2000S/3000S Solar Inverters

Table of Contents

1	Notes on this Manual	4
1.1	Area of validity	4
1.2	Target group.....	4
1.3	Symbols used in this manual.....	5
2	Safety.....	6
2.1	Intended use.....	6
2.2	Safety standards.....	6
2.3	Important safety information.....	7
2.4	Symbols on the label	10
2.5	Basic safety protection	11
3	Unpacking.....	12
3.1	Scope of delivery.....	12
3.2	Checking for transport damage.....	12
4	Mounting	13
4.1	Ambient conditions.....	13
4.2	Selecting the mounting location.....	15
4.3	Mounting the inverter with the wall bracket	16
5	Electrical Connection	18
5.1	Safety.....	18
5.2	System layout of units without integrated DC switch	19
5.3	Overview of the connection area.....	20
5.4	AC connection.....	21
5.4.1	Conditions for the AC connection.....	21

5.4.2 Grid connection.....	22
5.4.3 Second protective grounding connection.....	25
5.4.4 Residual current protection.....	26
5.4.5 Overvoltage category.....	27
5.4.6 Rating of miniature circuit-breaker.....	27
5.5 DC Connection.....	28
5.5.1 Requirements for the DC Connection.....	28
5.5.2 Assembling the DC connectors.....	29
5.5.3 Disassembling the DC connectors.....	31
5.5.4 Connecting the PV array.....	32
6 Communication.....	33
6.1 System monitoring via RS485.....	33
6.2 System monitoring via Ethernet.....	37
6.3 System monitoring via WiFi.....	38
6.4 Inverter demand response modes (DRED).....	39
6.5 Active power control with smart meter &ComBox.....	41
6.6 Communication with third-party devices.....	41
7 Operation.....	43
7.1 Overview of the control panel.....	43
7.1.1 Display.....	44
7.1.2 Control button.....	45
7.1.3 LEDs.....	45
7.2 Display messages.....	46
7.3 Language and safety regulation settings.....	48
7.3.1 Language setting.....	48
7.3.2 Safety regulation setting.....	48
8 Commissioning.....	50

8.1 Electrical checks	50
8.2 Mechanical checks.....	51
8.3 Start-Up	52
9 Disconnecting the Inverter from Voltage Sources.....	53
10 Technical Data	55
10.1 DC input data	55
10.2 AC output data	56
10.3 General data	57
10.4 Safety regulations	58
10.5 Efficiency	60
10.6 Power reduction.....	64
10.7 Tools and torque.....	66
11 Troubleshooting	67
12 Maintenance.....	69
12.1 Cleaning the contacts of the DC switch.....	69
12.2 Cleaning the heat sink	69
13 Recycling and disposal.....	70
14 Warranty	70
15 Contact.....	71

1 Notes on this Manual

General Notes

Zevelution is a transformerless solar inverter with a single MPP tracker.

It converts the direct current (DC) from a photovoltaic (PV) array to grid-compliant alternating current (AC) and feeds it into the utility grid.

1.1 Area of validity

This manual describes the mounting, installation, commissioning and maintenance of the following Zeversolar inverters:

Zevelution 1000S

Zevelution 1500S

Zevelution 2000S

Zevelution 3000S

Observe all documentation that accompanies the inverter. Keep them in a convenient place and available at all times.

1.2 Target group

This manual is for qualified electricians only, who must perform the tasks exactly as described.

All persons installing inverters must be trained and experienced in general safety which must be observed when working on electrical equipments. Installation personnel should also be familiar with local requirements, rules and regulations.

1.3 Symbols used in this manual

The safety precautions and general information are used in this manual as follows:

**DANGER**

DANGER indicates a hazardous situation which, if not avoided, will result in death or serious injury.

**WARNING**

WARNING indicates a hazardous situation which, if not avoided, can result in death or serious injury.

**CAUTION**

CAUTION indicates a hazardous situation which, if not avoided, can result in minor or moderate injury.

NOTICE

NOTICE indicates a situation which, if not avoided, can result in property damage.



INFORMATION provides tips which are valuable for the optimal installation and operation of the inverter.

2 Safety

2.1 Intended use

1. Zevelution converts the direct current from PV array into grid-compliant alternating current.
2. Zevelution is suitable for indoor and outdoor use.
3. Zevelution must only be operated with PV arrays (PV modules and cabling) of protection class II, in accordance with IEC 61730, application class A. Do not connect any sources of energy other than PV modules to the inverter.
4. PV modules with a high capacitance to ground must only be used if their coupling capacitance does not exceed $1.0\mu\text{F}$.
5. When the PV modules are exposed to sunlight, a DC voltage is supplied to this equipment.
6. When designing the PV system, ensure that the values comply with the permitted operating range of all components at all times. The free design program "Zeverplan" (<http://www.zeverplan.com>) will assist you.

2.2 Safety standards

Zevelution inverters comply with the EU Low-Voltage Directive 2006/95/EC and the EMC Directive 2004/108/EC. Zevelution also complies with the requirement for safety and EMC in Australia and New Zealand market. They are labeled with the CE mark and RCM mark.

For more information about certificates in other countries and regions, please visit website (<http://www.zeversolar.com>).

2.3 Important safety information

DANGER

- All work on the inverter must only be carried out by qualified personnel who have read and fully understood all safety information contained in this manual.
- Children must be supervised to ensure that they do not play with this device

DANGER

Danger to life due to high voltages of the PV array

When exposed to sunlight, the PV array generates dangerous DC voltage which is present in the DC conductors and the live components of the inverter. Touching the DC conductors or the live components can lead to lethal electric shocks. If you disconnect the DC connectors from the inverter under load, an electric arc may occur leading to electric shock and burns.

- Do not touch non-insulated cable ends.
- Do not touch the DC conductors.
- Do not touch any live components of the inverter.
- Have the inverter mounted, installed and commissioned only by qualified persons with the appropriate skills.
- If an error occurs, have it rectified by qualified persons only.
- Prior to performing any work on the inverter, disconnect it from all voltage sources as described in this document (see Section 9 "Disconnecting the Inverter from Voltage Sources").

WARNING

Risk of injury due to electric shock and fire caused by high leakage current

- The inverter must be reliably grounded in order to protect property and personal safety.

CAUTION

Risk of injury due to hot heat sink

- The heat sink may get hot during operation. Do not touch!

CAUTION

Possible damage to health as a result of the effects of electromagnetic radiation

- Please maintain a distance of at least 20cm from the inverter when it is in operation.

NOTICE

Grounding the PV array

- Comply with local regulations for grounding the PV array. We suggest the frames of PV modules must be reliably grounded.
- Do not ground any of the terminals of the strings.

NOTICE

Damage to the seal of the cover in sub-zero conditions









- If you open the cover in sub-zero condition, the sealing of the cover can be damaged. This can lead to moisture entering the inverter.
- Do not open the inverter at ambient temperatures lower than -5°C .
- If a layer of ice has formed on the seal of the cover in sub-zero conditions, remove it prior to opening the inverter (e.g. by melting the ice with warm air). Observe the applicable safety regulation.

NOTICE

Damage to the inverter due to electrostatic discharge

- Touching electronic components can cause damage to or destroy the inverter through electrostatic discharge.
- Ground yourself before touching any component.

2.4 Symbols on the label

Symbol	Explanation
	Beware of high voltage and operating current. The inverter operates at high voltage and current. Work on the inverter must only be carried out by skilled and authorized electricians.
	Beware of hot surfaces. The inverter can get hot during operation. Avoid contact during operation.
	Do not dispose of this inverter with household waste. For more information on disposal, please refer to Section 13 "Recycling and disposal".
	CE mark. The inverter complies with the requirements of the applicable EC guidelines.
	Certified safety Product is TUV-tested and complies with the requirements of the German Equipment and Product Safety Act.
	RCM Mark The product complies with the requirements of the applicable Australian low-voltage and electromagnetic compatibility standards.
	Capacitors discharge Before opening the covers, the inverter must be disconnected from the grid and PV array. Wait at least 5 minutes to allow the energy storage capacitors to fully discharge.
	Refer to the manual accompanying the inverter.
	Risk of danger, warning and caution Safety information important for human safety. Failure to observe the safety information in this manual may result in injury or death.

2.5 Basic safety protection

We provide the following safety protection:

- 1) Over-voltage, under-voltage protection;
- 2) Over-frequency, under-frequency protection;
- 3) Over-temperature monitoring;
- 4) Residual current monitoring;
- 5) Insulation monitoring
- 6) Anti-islanding protection;
- 7) DC feed-in monitoring;

3 Unpacking

3.1 Scope of delivery

Object	Description	Quantity
A	Inverter	1 piece
B	Wall mounting bracket	1 piece
C	Mounting accessory kit: Wall anchors and hexagon bolts (2×) M5×12 mm pan head screw (2×) *M5×14 mm pan head screw (1×) *Ground washer (2×)	1 set
D	DC connector	1 pair
E	Documentation	1 set
F	WiFi antenna	1 piece (optional)
G	Smart meter Connector	1 piece (optional)

* One spare part for cover mounting



A

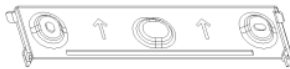

B



C



D

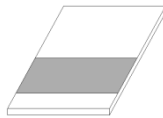

E

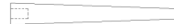

F



G

Carefully check all of the components in the carton. If anything is missing, contact your dealer.

3.2 Checking for transport damage

Thoroughly inspect the packaging upon delivery. If you detect any damage to the packaging which indicates the inverter may have been damaged, inform the responsible shipping company immediately. We will be glad to assist you if required.

4 Mounting

4.1 Ambient conditions

1. Be sure the inverter is installed out of the reach of children.
2. Mount the inverter in areas where it cannot be touched inadvertently.
3. Ensure good access to the inverter for installation and possible service.
4. To make sure that heat can dissipate, observe the following minimum clearance to walls, other inverters, or objects:

Direction	Min. clearance(mm)
above	300
below	300
sides	200

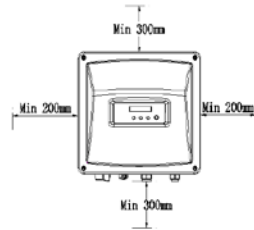

Clearances for one inverter

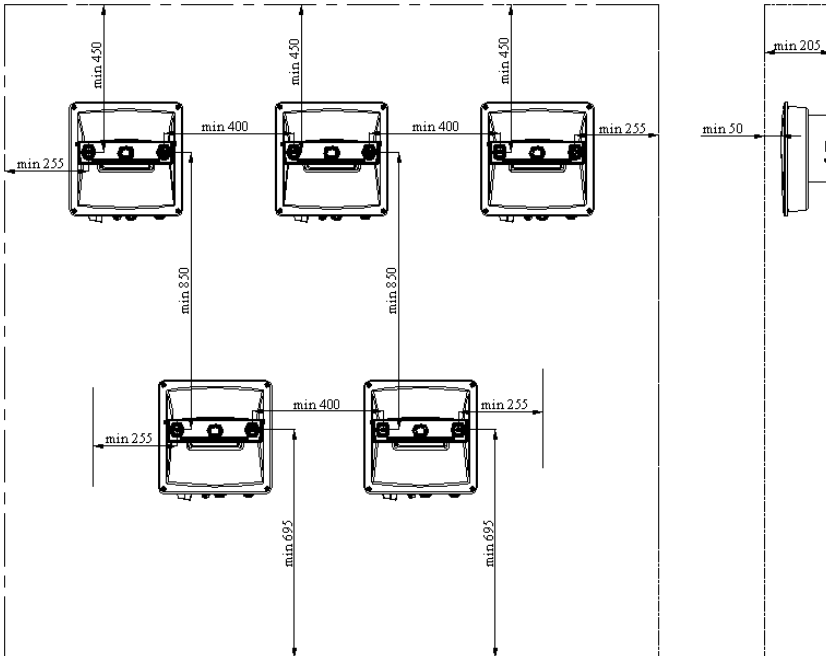

Clearances for multiple inverters

5. The ambient temperature should be below 40°C to ensure optimal operation.
6. Recommend to mount the inverter under the shaded site of the building or mount an awning above the inverter.
7. Avoid exposing the inverter to direct sunlight, rain and snow to ensure optimal operation and extend service life.

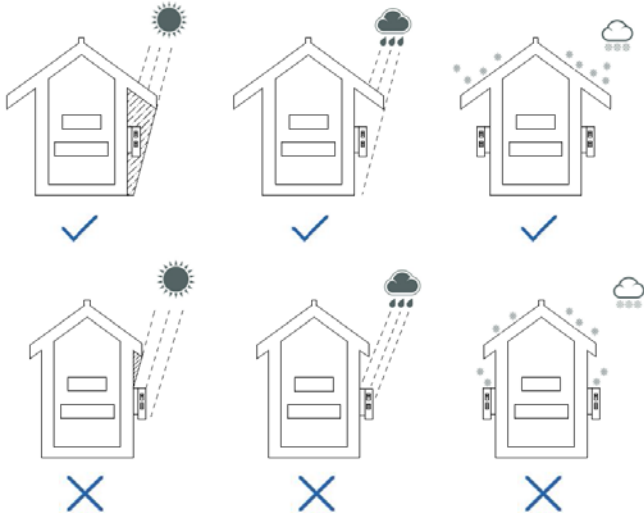

8. The mounting method, location and surface must be suitable for the inverter's weight and dimensions.
9. If mounted in a residential area, we recommend mounting the inverter on a solid surface. Plasterboard and similar materials are not recommended due to audible vibrations when in use.
10. Do not put any objects on the inverter.
11. Do not cover the inverter.

4.2 Selecting the mounting location

DANGER

Danger to life due to fire or explosion

- Do not mount the inverter on flammable construction materials.
- Do not mount the inverter in areas where flammable materials are stored.
- Do not mount the inverter in areas where there is a risk of explosion.

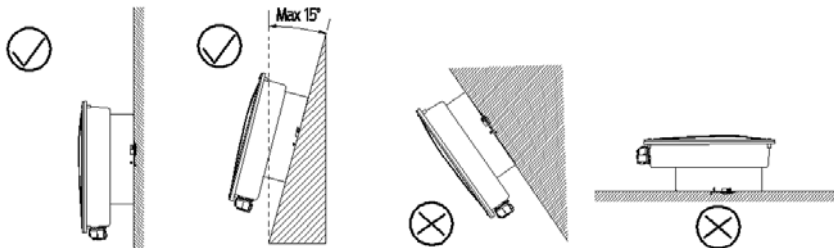

1. Mount the inverter vertically or tilted backward by a maximum of 15°.
2. Never mount the inverter tilted forward or sideways.
3. Never mount the inverter horizontally.
4. Mount the inverter at eye level to make it easy to operate and to read the display.
5. The electrical connection area must point downwards.

4.3 Mounting the inverter with the wall bracket

⚠ CAUTION

Risk of injury due to the heavy weight of the inverter

- When mounting, take into account that the inverter weighs approx. 7.5kg.

Mounting procedures:

1. Use the wall bracket as a drilling template and mark the positions of the drill holes. Drill 2 holes required using a drill with 10 mm bit. The holes must be about 70 mm deep. Keep the drill vertical to the wall, and hold the drill steady to avoid tilted holes.

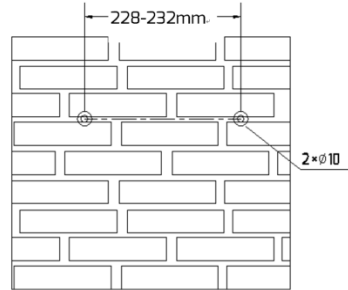

⚠ CAUTION

Risk of injury due to the inverter falls down

- Before inserting the wall anchors, measure the depth and distance of the holes.

2. After drilling holes in the wall, place two screw anchors into the holes, then attach the wall mounting bracket to the wall using the self-tapping screws and washers delivered with the inverter.

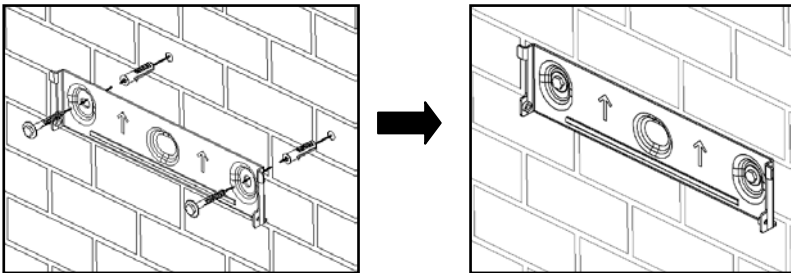

3. Holding the inverter and attach it tilted slightly downwards to the wall bracket.

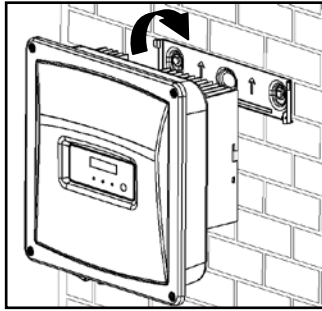

4. Check both sides of the heatsink to ensure that it is securely in place.

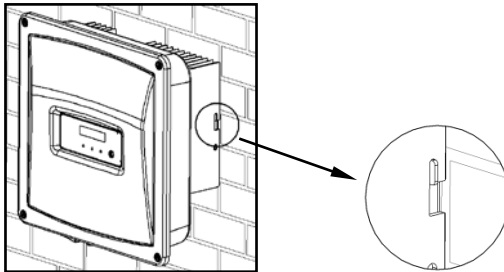

5. Push the inverter as far as possible and attach it to both sides of the wall bracket using the M5 screws.

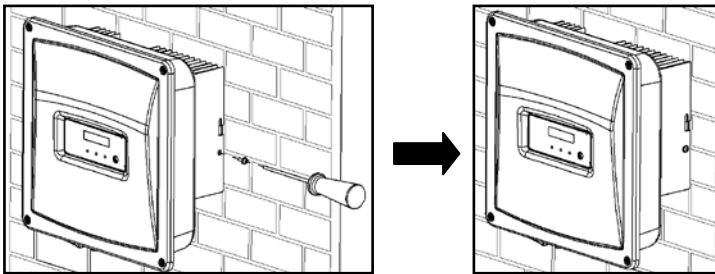

If a second protective conductor is required in installation site, ground the inverter and secure it so that it cannot be lifted off the wall bracket (see section 5.4.3 "Second protective grounding connection").

Dismante the inverter in reverse order.

5 Electrical Connection

5.1 Safety

DANGER

Danger to life due to high voltages of the PV array

When exposed to sunlight, the PV array generates dangerous DC voltage which is present in the DC conductors and the live components of the inverter. Touching the DC conductors or the live components can lead to lethal electric shocks. If you disconnect the DC connectors from the inverter under load, an electric arc may occur leading to electric shock and burns.

- Do not touch non-insulated cable ends.
- Do not touch the DC conductors.
- Do not touch any live components of the inverter.
- Have the inverter mounted, installed and commissioned only by qualified persons with the appropriate skills.
- If an error occurs, have it rectified by qualified persons only.
- Prior to performing any work on the inverter, disconnect it from all voltage sources as described in this document(see Section 9 "Disconnecting the Inverter from Voltage Sources").

WARNING

Risk of injury due to electric shock

- The inverter must be installed only by trained and authorized electricians.
- All electrical installations must be done in accordance with the National Wiring Rules standards and all locally applicable standards and directives.

NOTICE

Damage to the inverter due to electrostatic discharge

- Touching electronic components can cause damage to or destroy the inverter through electrostatic discharge.
- Ground yourself before touching any component.

5.2 System layout of units without integrated DC switch

Local standards or codes may require that PV systems are fitted with an external DC switch on the DC side. The DC switch must be able to safely disconnect the open-circuit voltage of the PV array plus a safety reserve of 20%.

Install a DC switch to each PV string to isolate the DC side of the inverter. We recommend the following electrical connection:

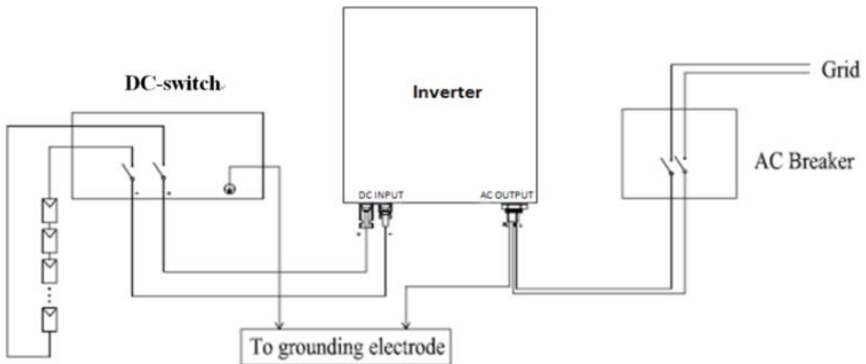

5.3 Overview of the connection area

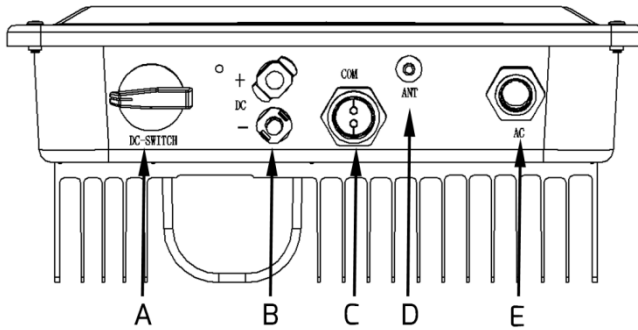

Object	Description
A	DC SWITCH (optional): switch on or off for PV-load.
B	DC input: plug-in connector to connect the strings.
C	COM: connect the monitoring device with network cable.
D	ANT (optional): antenna, transmit and receive Wi-Fi signal.
E	AC OUTPUT: connect the grid.

5.4 AC connection

DANGER

Danger to life due to high voltages in the inverter

- Before establishing the electrical connection, ensure that the miniature circuit-breaker is switched off and cannot be reactivated.

5.4.1 Conditions for the AC connection

Cable Requirements

The grid connection is established using three conductors (L, N, and PE).

We recommend the following specifications for stranded copper wire.

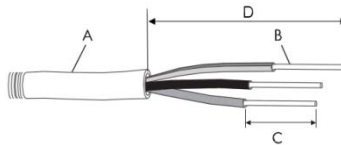

Object	Description	Value
A	External diameter	5 to 13 mm
B	Conductor cross-section	2.5 to 6 mm ²
C	Stripping length of the insulated conductors	approx. 12 mm
D	Stripping length of the outer sheath of AC cable	approx. 70 mm

Larger cross-sections should be used for longer cables.

Cable design

The conductor cross-section should be dimensioned to avoid power loss in cables exceeding 1% of rated output power.

The higher grid impedance of the AC cable makes it easier to disconnect from the grid due to excessive voltage at the feed-in point.

The maximum cable lengths depend on the conductor cross-section as follows:

Conductor cross-section	Maximum cable length			
	Zeverlution 1000S	Zeverlution 1500S	Zeverlution 2000S	Zeverlution 3000S
2.5 mm ²	46m	37 m	28 m	17 m
4 mm ²	74 m	59 m	44 m	27 m
6 mm ²	110 m	89 m	67 m	40 m

The required conductor cross-section depends on the inverter rating, ambient temperature, routing method, cable type, cable losses, applicable installation requirements of the country of installation, etc.

5.4.2 Grid connection

WARNING

Risk of injury due to electric shock and fire caused by high leakage current

- The inverter must be reliably grounded in order to protect property and personal safety.
- The PE wire should longer than 20mm during strip the outer sheath of AC cable.

NOTICE

Damage to the seal of the cover in sub-zero conditions

- If you open the cover in sub-zero condition, the sealing of the cover can be damaged. This can lead moisture entering the inverter.
- Do not open the inverter at ambient temperatures lower than -5°C.
- If a layer of ice has formed on the seal of the cover in sub-zero conditions, remove it prior to opening the inverter(e.g. by melting the ice with warm air). Observe the applicable safety regulation.

Procedure:

1. Switch off the miniature circuit-breaker and secure it against being inadvertently switched back on.
2. Loosen the screws of the cover using a screwdriver (T25) and remove the cover.

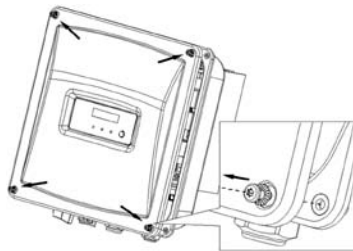

loosen the screws of the cover

- During loosening the screws of the cover, it is not necessary to take off the screws and conical spring washers, which can remain on the cover and will not fall off.

3. Strip the AC cable insulation. Strip the insulation of L, N, and PE by 12 mm each. Shorten L and N by 10 mm more than PE.

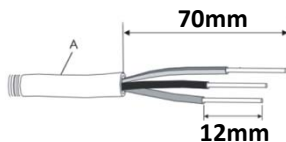

4. Route the AC cable into the inverter through the M20 cable gland.
5. If necessary, slightly loosen the swivel nut of the cable gland.
6. Insert bared conductor into the cord end terminal and crimp the contact.

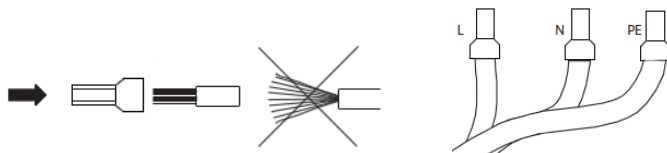

7. Connect the AC cable to the screw terminal block, using a flat-blade screwdriver (blade: 1×5.5) with a torque of 1.2 to 1.5Nm.

- Insert the protective conductor (green-yellow) into the screw terminal with the grounding sign and tighten the screw.
- Insert the neutral conductor (blue) into the screw terminal with N sign and tighten the screw.
- Insert the L conductor (brown or black) into the screw terminal with L sign and tighten the screw.

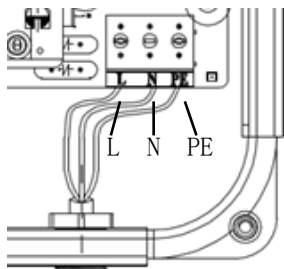

8. Make sure the insulated conductors are securely connected.
9. Tighten the swivel nut of the cable gland by using a torque of 2 to 2.5Nm and check the tightness.
10. Secure the cover in the sequence 1 to 4 (torque: 2.2 - 2.5 Nm) using a screwdriver (T25).

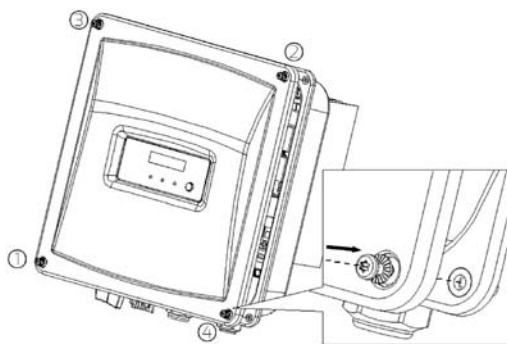

5.4.3 Grounding connection

NOTICE

In case of operation on a Delta-IT Grid type, in order to ensure safety compliance in accordance with IEC 62109, the following step should be taken:

The second protective earth/ground conductor, with a diameter of at least 10 mm² and be made from copper, should be connected to the designated earth point on the inverter.

Procedure:

1. Take the terminal lug which is not included in the scope of delivery, insert the stripped grounding conductor into the terminal lug and crimp the contact.
2. Align the plain washer, the terminal lug with the grounding conductor, and the ground washer on the screw. The teeth of the ground washer must be facing the heat sink.
3. Insert the screw through the hole at the side of the heat sink, and tighten it firmly into the wall bracket (torque: 2.2-2.5Nm).

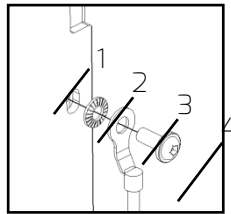

Information on grounding components:

Object	Description
1	Heat sink
2	Ground washer
3	M5 terminal lug with protective conductor
4	M5×12 pan head screw

5.4.4 Residual current protection

The inverter is equipped with an all-pole sensitive residual current monitoring unit (RCMU) with an integrated differential current sensor which fulfills the requirements of DIN VDE 0100-712 (IEC60364-7-712:2002).

Therefore an external residual current device (RCD) is not required. If an external RCD needs to be installed because of local regulations, a RCD type A or type B can be installed as an additional safety measure.

The all-pole sensitive residual current monitoring unit (RCMU) detects alternating and direct differential currents. The integrated differential current sensor detects the current difference between the neutral conductor and the line conductor. If the current difference increases suddenly, the inverter disconnects from the grid. The function of the all-pole sensitive residual current monitoring unit (RCMU) has been tested in accordance with IEC 62109-2.



Rating of the external residual current device

- If an external residual current device (RCD) is required in a TT or TN-S system, install a residual current device which trips at a residual current of 100 mA or higher.
- For each connected inverter, a RCD with 100mA rated residual current has to be provided. The rated residual current of the RCD must be equal to at least the sum of the rated residual currents of the connected inverters. That means that, if, for example, two transformerless inverters are connected, the rated residual current of the RCD must be at least 200 mA.

5.4.5 Overvoltage category

The inverter can be deployed in grids of installation category III or lower, as defined under IEC 60664-1. This means that it can be permanently connected at the grid-connection point in a building. In installations involving long outdoor cable routing, additional overvoltage-reducing measures must be taken so that the overvoltage category is reduced from IV to III.

5.4.6 Rating of miniature circuit-breaker

DANGER

Danger to life due to fire

- You must protect each inverter with an individual miniature circuit-breaker in order that the inverter can be disconnected safely.

No load should be applied between the circuit-breaker and the inverter. Use dedicated circuit-breakers with load switch functionality for load switching. The selection of the circuit-breaker rating depends on the wiring design (wire cross-section area), cable type, wiring method, ambient temperature, inverter current rating etc. Derating of the circuit breaker rating may be necessary due to self-heating or if exposed to heat. The maximum output currents of the inverters can be found in the following table.

Type	Zeverlution 1000S	Zeverlution 1500S	Zeverlution 2000S	Zeverlution 3000S
Max. output current	5.5A	7.5 A	10 A	15 A
Recommended fuse type gL/gG or comparable circuit breaker rating	16 A	16 A	16 A	25A

5.5 DC Connection

DANGER

Danger to life due to high voltages in the inverter

- Before connecting the PV array, ensure that the DC switch is switched off and that it cannot be reactivated.
- Do not disconnect the DC connectors under load.

5.5.1 Requirements for the DC Connection



Use of Y adapters for parallel connection of strings

The Y adapters must not be used to interrupt the DC circuit.

- Do not use the Y adapters in the immediate vicinity of the inverter. The adapters must not be visible or freely accessible.
- In order to interrupt the DC circuit, always disconnect the inverter as described in this document (see Section 9 "Disconnecting the Inverter from Voltage Sources").

Requirements for the PV modules of a string:

- PV modules of the connected strings must be of: the same type, identical alignment and identical tilt.
- The thresholds for the input voltage and the input current of the inverter must be adhered to (see Section 10.1 "Technical DC input data").
- On the coldest day based on statistical records, the open-circuit voltage of the PV array must never exceed the maximum input voltage of the inverter.
- The connection cables of the PV modules must be equipped with the connectors included in the scope of delivery.
- The positive connection cables of the PV modules must be equipped with the positive DC connectors. The negative connection cables of the PV modules must be equipped with the negative DC connectors.

5.5.2 Assembling the DC connectors

DANGER

Danger to life due to high voltages on DC conductors

When exposed to sunlight, the PV array generates dangerous DC voltage which is present in the DC conductors. Touching the DC conductors can lead to lethal electric shocks.

- Cover the PV modules.
- Do not touch the DC conductors.

Assemble the DC connectors as described below. Be sure to observe the correct polarity. The DC connectors are marked with the symbols "+" and "-".

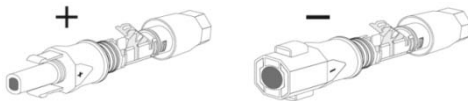

Cable requirements:

The cable must be of type PV1-F, UL-ZKLA or USE2 and comply with the following properties:

- ❖ External diameter: 5 mm to 8 mm
- ❖ Conductor cross-section: 2.5 mm² to 6 mm²
- ❖ Number of conductors: at least 7
- ❖ Nominal voltage: at least 600V

Proceed as follows to assemble each DC connector.

1. Strip 12 mm off the cable insulation.

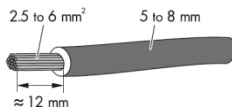

2. Route the stripped cable all the way into the DC connector. Ensure that the stripped cable and the DC connector have the same polarity.

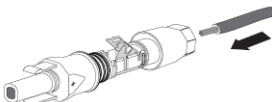

3. Press the clamping bracket down until it audibly snaps into place.

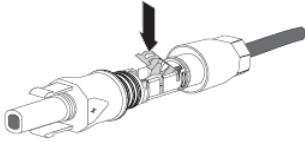

4. Ensure that the cable is correctly positioned:

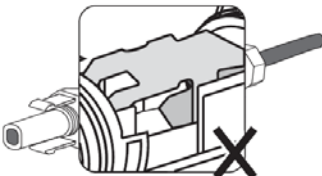
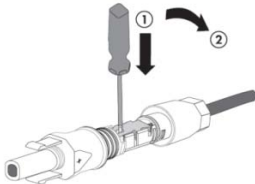
Result	Measure
<p>If the stranded wires are visible in the chamber of the clamping bracket, the cable is correctly positioned.</p> 	<ul style="list-style-type: none"> Proceed to step 5.
<p>If the stranded wires are not visible in the chamber, the cable is not correctly positioned.</p> 	<ul style="list-style-type: none"> Release the clamping bracket. To do so, insert a flat-blade screwdriver (blade width: 3.5 mm) into the clamping bracket and lever it open.  <ul style="list-style-type: none"> Remove the cable and go back to step 2.

5. Push the swivel nut up to the thread and tighten (torque: 2 Nm).

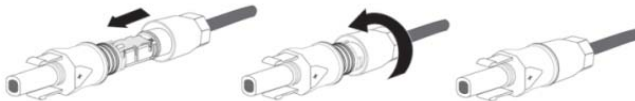

5.5.3 Disassembling the DC connectors

DANGER

Danger to life due to high voltages on DC conductors
When exposed to sunlight, the PV array generates dangerous DC voltage which is present in the DC conductors. Touching the DC conductors can lead to lethal electric shocks.

- Cover the PV modules.
- Do not touch the DC conductors.

1. Unscrew the swivel nut.



2. To release the DC connector, insert a flat-blade screwdriver (blade width: 3.5 mm) into the side catch mechanism and lever open.

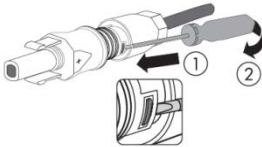

3. Carefully pull the DC connector apart.



4. Release the clamping bracket. To do so, insert a flat-blade screwdriver (blade width: 3.5 mm) into the clamping bracket and lever it open.

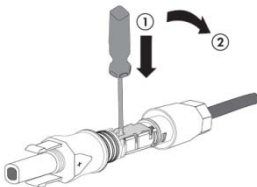

5. Remove the cable.

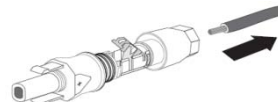

5.5.4 Connecting the PV array

NOTICE

The inverter can be destroyed by overvoltage

If the voltage of the strings exceeds the maximum DC input voltage of the inverter, it can be destroyed due to overvoltage. All warranty claims become void.

- Do not connect strings with an open-circuit voltage greater than the maximum DC input voltage of the inverter.
- Check the design of the PV system.

1. Ensure that the individual miniature circuit-breaker is switched off and ensure that it cannot be accidentally reconnected.
2. Ensure that the DC switch is switched off and ensure that it cannot be accidentally reconnected.
3. Ensure that there is no ground fault in the PV array.
4. Check whether the DC connector has the correct polarity.
If the DC connector is equipped with a DC cable having the wrong polarity, the DC connector must be reassembled. The DC cable must always have the same polarity as the DC connector.
5. Ensure that the open-circuit voltage of the PV array does not exceed the maximum DC input voltage of the inverter.
6. Connect the assembled DC connectors to the inverter until they audibly snap into place.
7. Ensure that all DC connectors are securely in place.

NOTICE

Damage to the inverter due to moisture and dust penetration

- Seal the unused DC inputs with sealing plugs so that moisture and dust cannot penetrate the inverter.
- Make sure all DC connectors are securely sealed.

6 Communication

6.1 System monitoring via RS485

This inverter is equipped with RJ45 interfaces for multipoint communication.

One ZeverCom/ZeverManager connects inverters via an RS485 bus. The overall length of the network cable should not exceed 1,000 m. The monitoring system layout for inverters is as follows.

I

The ZeverCom/ZeverManager connects to the inverter via the RJ45 interface, and it connects to the router via Ethernet.

We offer a remote monitoring platform called "**ZeverCloud**". You can install the "**ZeverCloud**" application on a smart phone using Android or an iOS operating systems.

You can also visit the website (<http://zevercloud.com>) for system information.

The pin assignment of the RJ45 socket is as follows:

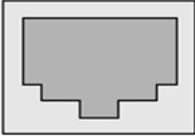
Pin1----- TX_RS485A	
Pin2-----TX_RS485B	
Pin3-----RX_RS485A	
Pin4-----GND	
Pin5-----GND	
Pin6-----RX_RS485B	
Pin7-----+7V	
Pin8-----+7V	

The network cable meeting the EIA/TIA 568A or 568B standard must be UV resistant if it is to be used outdoors.

Connect the network cable:

NOTICE

The inverter can be destroyed by wrong communication wiring

- Internal components of the inverter can be irreparably damaged due to incorrect wiring between the power wire and signal wire. All the warranty claim will be invalid.
- Please check the wiring of the RJ45 connector before crimping the contact.

NOTICE

Damage to the inverter due to moisture and dust penetration





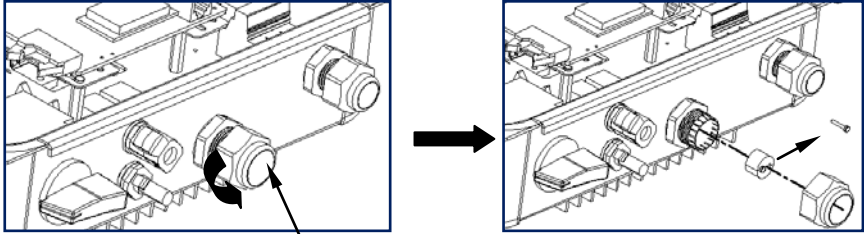

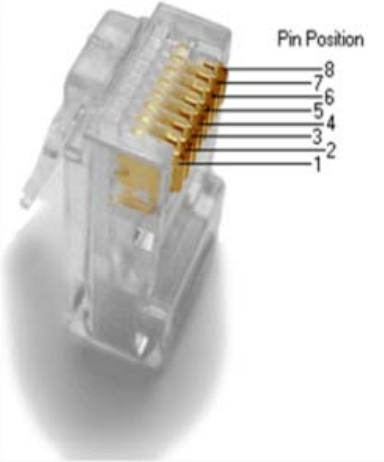

- If the cable gland are not mounted properly, the inverter can be destroyed due to moisture and dust penetration. All the warranty claim will be invalid.
- Make sure the cable gland has been tightened firmly.

1. Loosen the screws of the cover using a screwdriver (T25) and remove the cover. (see Section 5 " Electrical Connection ").
2. Unscrew the swivel nut of the M25 cable gland, remove the filler-plug from the cable gland and keep it well. If there is only one network cable, please keep a filler-plug in the remaining hole of the sealing ring against water ingress.



M25 cable gland for RJ45

3. Current pin assignment for the network cable as per EIA/TIA 568 standard:

Pin	T568A Color	Pins on plug face (socket is reversed)
1	 white/green stripe	
2	 green solid	
3	 white/orange stripe	
4	 blue solid	
5	 white/blue stripe	
6	 orange solid	
7	 white/brown stripe	
8	 brown solid	

4. Route the network cable into the inverter through the M25 cable gland, and connect it to the RJ45 keystone socket on the power-PCBA.

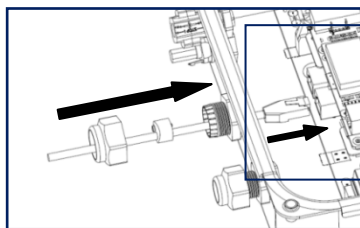

If the inverter has integrated ComBox (with Ethernet module), you need to insert the network cable into the RJ45 keystone socket on the ComBox.

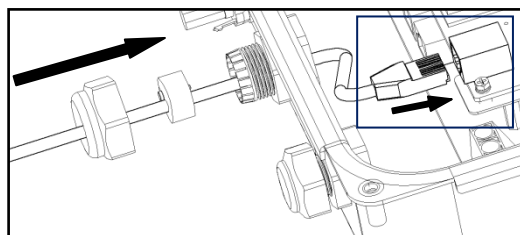

5. Connect the inverter to ZeverCom/ZeverManager or another communication device via the above- mentioned network cable.

6. Press the sealing ring with the network cable into the cable gland, and then tighten the swivel nut firmly (torque: 2.5-3.0Nm). Make sure the cable gland is mounted properly. The cable gland must be adequately locked to prevent any movement of the cable.

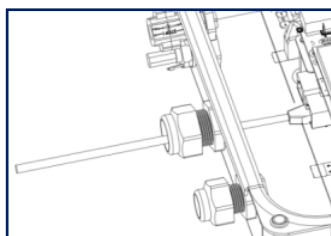

7. Secure the cover (torque: 2.2 - 2.5 Nm) using a screwdriver (T25).

Disassemble the network cable in reverse order.

6.2 System monitoring via Ethernet

User can monitor the inverter through the integrated ComBox with Ethernet module (optional). The connection diagram between the inverter and internet with network cable is shown as follows.

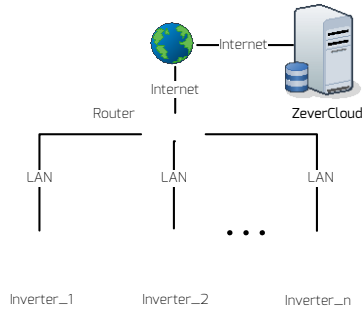

Possible reason of communication failure due to closed port

- The ComBox uses port #6655 and #80 communicates with the **ZeverCloud**. Both of these two ports must be opened, or else the ComBox cannot connect to the **ZeverCloud** and upload data

The inverter is connected to the network by simply connecting the network cable from the router to the Ethernet port on the ComBox. For connecting the network cable, please refer to the relative instruction at section 6.1.



Possible reason of communication failure due to DHCP

- The router needs to support DHCP services if the ComBox use the DHCP function.

The inverter obtains an IP address from the router via DHCP automatically and shows it on the display. The time it takes to connect to the network depends on the network communication conditions.

6.3 System monitoring via WiFi

User can monitor the inverter through the integrated ComBox with WiFi module (optional). The connection diagram between the inverter and internet with a WiFi connection is shown as follows.

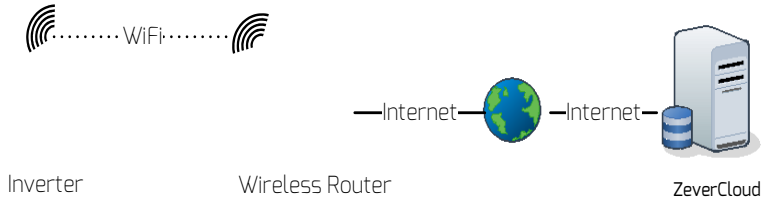

Mounting the antenna:

Take the antenna included in the scope of delivery.

Tighten the antenna into the WIFI connection port by hand. Make sure the antenna is securely connected.

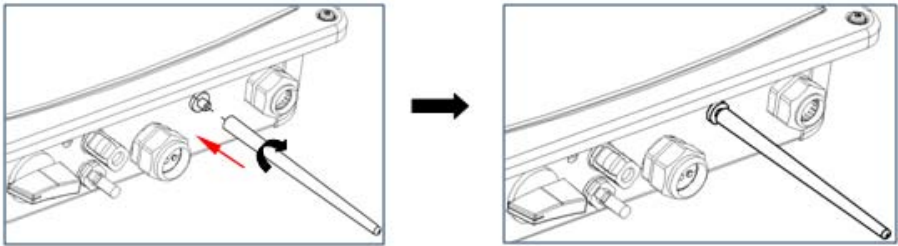

More operating information for ComBox:

In order to achieve remote monitoring reliably, please visit website (<http://www.zeversolar.com>) and download the ComBox's manual for detailed information, you can also find how to use Solarcloud in it.

6.4 Inverter demand response modes (DRED)



DRMS application description

- Only applicable to AS/NZS4777.2:2015.
- DRMO, DRM5, DRM6, DRM7, DRM8 are available.

The inverter shall detect and initiate a response to all supported demand response commands . demand response modes are described as follows:

Mode	Requirement
DRM 0	Operate the disconnection device
DRM 1	Do not consume power
DRM 2	Do not consume at more than 50% of rated power
DRM 3	Do not consume at more than 75% of rated power AND Source reactive power if capable
DRM 4	Increase power consumption (subject to constraints from other active DRMs)
DRM 5	Do not generate power
DRM 6	Do not generate at more than 50% of rated power
DRM 7	Do not generate at more than 75% of rated power AND Sink reactive power if capable
DRM 8	Increase power generation (subject to constraints from other active DRMs)

The RJ45 socket pin assignments for demand response modes as follows:

Pin1----- DRM 1/5	
Pin2----- DRM 2/6	
Pin3----- DRM 3/7	
Pin4----- DRM 4/8	
Pin5----- RefGen	
Pin6----- Com/DRMO	
Pin7-----N/A	
Pin8----- N/A	

Connect the network cable:

NOTICE

Damage to the inverter due to moisture and dust penetration

- If the cable gland are not mounted properly, the inverter can be destroyed due to moisture and dust penetration. All the warranty claim will be invalid.
- Make sure the cable gland has been tightened firmly.

1. Loosen the screws of the cover using a screwdriver (T25) and remove the cover. (see Section 5.4.2).

2. Unscrew the swivel nut of the M25 cable gland, remove one filler-plug from the cable gland and keep it well. If there is only one network cable, please keep another filler-plug in the remaining hole of the sealing ring against water ingress.

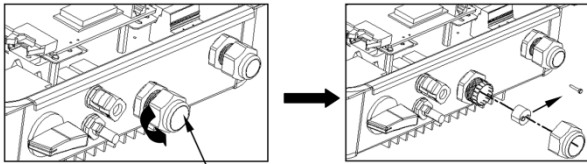

M25 cable gland for network cable

3. Insert the network cable into the RJ45 socket on the upper circuit board(ComBox).

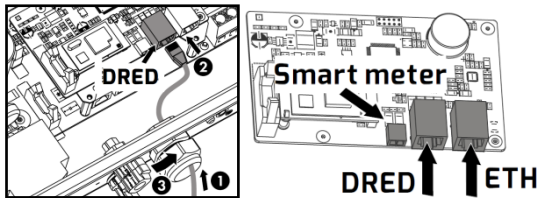

4. Connect the inverter to DRED via the above mentioned network cable.

5. Press the sealing ring with the network cable into the cable gland, and then tighten the swivel nut firmly. Make sure the cable gland is mounted properly. The cable gland must be adequately locked to prevent any movement of the cable.

6. Secure the cover (screw driver type: T25,torque: 2.5Nm).

6.5 Active power control with smart meter & ComBox

The inverter can control active power output via connecting smart meter and ComBox integrated in Zeversolar's inverter, following is the system connection mode.

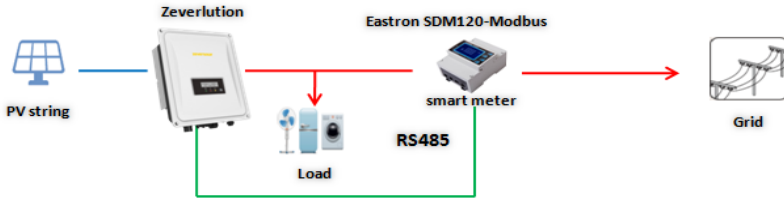

Smart meter as above SDM120-Modbus connecting method and setting baud rate method for modbus please refer to its user manual.

NOTICE

Possible reason of communication failure due to incorrect connection

- ComBox only supports single inverter to do active power control
- The overall length of the cable from combox to smart meter should not exceed 1,000 m

Connect the smart meter to the inverter:

1. Cable Requirements:



Object	Description	Value
A	External diameter	5 to 8 mm
B	Conductor cross-section	0.14 to 1.5 mm ²
C	Stripping length of the insulated conductors	approx. 9 mm
D	Stripping length of the outer sheath of the cable	approx. 30 mm

2. Connect the conductors to the supplied smart meter connector in accordance with the symbol "A" and "B". When doing so, ensure the conductors are plugged completely into the terminal up to the insulation.

3. Route the cable into inverter through the cable gland, referring to the network cable connection (Section 6.1).

4. Plug the assembled smart meter connector into the pin

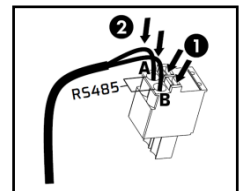

connector.

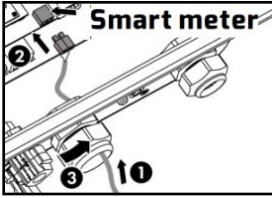

5. Push the seal insert back into the cable gland. Tighten the swivel nut slightly.

6. Place the cover on the housing, then tighten all 4 screws with a Torx screwdriver (screw driver type: T25, torque: 2.2Nm).

NOTICE

Possible reason of communication failure due to the wrong meter

- The smart meter brand:EASTRON
- Supported model:SDM120-Modbus,SDM220-Modbus,SDM230-Modbus
- Must set the meter baud rate for modbus to 9600bps

More meter details are available at <http://www.eastron.com.cn> or <http://www.eastrongroup.com/>

6.6 Communication with third-party devices

Zeverlution inverters can communicate with Solarlog or Meteocontrol, in other words, you can use Solarlog or Meteocontrol to monitor Zeverlution inverters. For more information, please refer to their user manual.

7 Operation

The information provided here covers the LED indicators, control button and display messages, and the language and safety regulation settings.

7.1 Overview of the control panel

The inverter is equipped with a text display, three LEDs indicators and a control button.

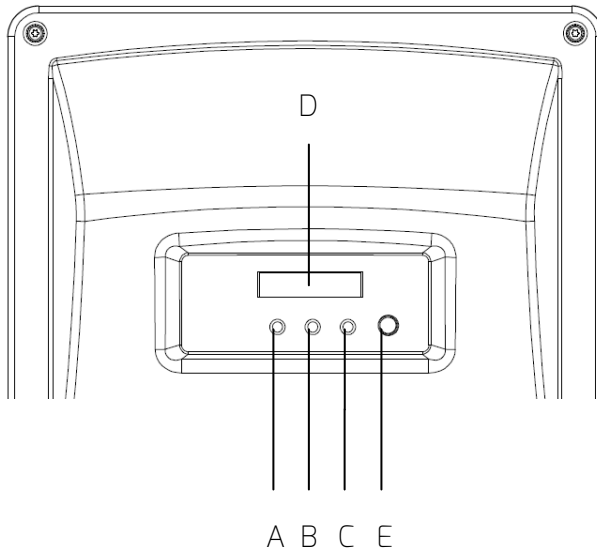

Object	Description
A	Normal (Green LED)
B	Fault (Red LED)
C	Communication (Yellow LED)
D	Display
E	Control button

7.1.1 Display

The display messages consist of 16 characters*2 lines. The bottom line always shows the current output (Pac = xxxx.xW). The top line shows the current state by default, it will switch to different state information by pressing the control button, as follows. At the last item, the first line display ComBox IP addr(it will show 0.0.0.0 without Combox), and bottom display state that connect **ZeverCloud** or not.

Line 1	State information ↓ E-today ↓ E-total ↓ Vpv ↓ Ipv ↓ Vac ↓ Iac ↓ Frequency ↓ Model ↓ Set Language ↓ Version ↓ Serial No. ↓ IP Addr ↻	Daily energy Energy generated since the inverter has been installed DC input voltage DC input voltage DC input current Grid volt Present output current Grid frequency Type name Selected language Firmware version Serial number ComBox IP addr
Line 2	Pac = xxxx.xW ↓ ↑ connect state	Current output power Connect solarcloud or not

7.1.2 Control button

The inverter has a control button which is necessary to switch between the various displays for measured values and data, enter next entry and lock the expected information.

The display menus wrap around, which means that when you arrive at the last entry, the first entry is displayed when you press the button again.

You can freeze the display as follows:

Press the button for 5s when it shows the information you desire, and do not release the button until you see "LOCK". The display will show the selected information until you press the button again or the operating state of the inverter changes.

To save power, the backlight of the display turns off automatically after 10s. Press the button again to activate it.

7.1.3 LEDs

The inverter is equipped with three LED indicators "green", "red" and "yellow" which provide information about the various operating states.

Green LED:

The green LED is lit when the inverter is operating normally.

Yellow LED:

The yellow LED flashes during communication with other devices e.g. ZeverCom/ZeverManager, Solarlog etc. Also, the yellow LED flashes during firmware update through RS485.

Red LED:

The red LED is lit when the inverter has stopped feeding power into the grid due to a fault. The corresponding error code will be shown on the display.

7.2 Display messages

Along with the various operating states, various messages may be shown on the display, as follows.

State	Error code	Description	Causes
Initializat-i on	/	Waiting	Initial PV voltage is between minimum DC input voltage and the start-up DC input voltage of the inverter.
	/	Checking	The inverter is checking the feed-in conditions after the start-up PV voltage exceeds the initial DC input voltage of the inverter and that both the grid voltage and frequency are normal .
	/	Reconnect	The inverter is checking feed-in conditions after the last fault has been solved.
Normal	/	Normal	The inverter is feeding energy into grid normally.
fault	1	SCI Fault	Communication between the master and slave CPU has failed.
	2	EEPROM R/W Fault	Reading or writing of EEPROM fails
	3	Rly-Check Fault	Output relay has failed.
	4	DC INJ. High	Output DC feed-in exceeds the permitted upper limit.
	6	High DC Bus	The voltage of DC busbar exceeds the permitted upper limit.
	8	AC HCT Fault	Output current is abnormal
	9	GFCI Fault	Ground-fault detection circuit is abnormal
	33	Fac Fault	The grid frequency is outside the permitted range.
	10	Device Fault	Unknown Error

fault	34	Vac Fault	The grid voltage is outside the permitted range.
	35	No Utility Grid Available	The utility cannot be detected, which may be caused by no utility, grid disconnected, AC cables damaged, fuse broken or stand-alone grid.
	36	Residual current fault	The residual current exceeds the permitted upper limit.
	37	PV Overvoltage	The voltage of the strings exceeds the permitted upper limit.
	38	ISO Fault	The PV array's insulation resistance to ground is below the permitted value, or the electrical insulation inside the inverter has failed.
	40	Over Temp.	The internal temperature exceeds the permitted value.
	41	Vac differs for M-S	A different value of grid voltage has been detected by the master and slave MCU.
	42	Fac differs for M-S	A different value of grid frequency has been detected by the master and slave MCU.
	43	Residual current differs for M-S	A different value of residual current has been detected by the master and slave MCU.
	44	DC Inj. differs for M-S	A different value of DC feed-in has been detected by the master and slave MCU.
	45	Fac,Vac differs for M-S	A different value of grid frequency and voltage has been detected by the master and slave MCU.
47	Consistent Fault	A different value has been detected by the master and slave MCU.	

	61	DRED Communication Fault	DRED Communication Fails (S9 open)
	62	DRED operate disconnection	Operate the disconnection device (S0 close)

An interruption in the supply voltage of $\leq 3s$ does not result in any loss of failure reports (according to VDE-AR-N 4105).

7.3 Language and safety regulation settings

Before setting, switch on the DC switch, and ensure that the circuit breaker is switched off and cannot be reactivated, while the inverter should be reliably grounded.

7.3.1 Language setting

The inverter provides two languages: English and German.

Press the button for approx. 5s at the entry of "Set Language" to enter the language menu and select the language. The display will switch to current state information automatically and the language setting will be saved at the same time unless you press the button again within approximately 10s.

7.3.2 Safety regulation setting

There is a safety regulation setting function in the inverter. You can choose different safety regulations according to the local requirements. If you are in Germany or Australia, you don't need to set the safety regulation because the default is correctly set for this countries. **Additional information on Australian specific inverter settings and features are available at Zerversolar Australia Youtube Official Channel, video link is here** (https://www.youtube.com/channel/UC4F_uayYsAYNm8ExCLnGcH8Q)

Set the safety regulation as described below:

Step 1:

Connect the inverter with the PV modules and switch on the DC switch; the LCD displays the following:

Error Code: 35
Pac= 0.0W

Step 2:

Press the control key (see section 7.1.1) approx. once per second until the LCD display shows:

ZL xxxxS
Pac= 0.0W

Then press the control key for 10 seconds. The LCD will show the safety regulation as illustrated below:

DE VDE-AR-N 4105 stands for the German safety regulation (VDE4105)

DE VDE-AR-N 4105
Pac= 0.0W

Step 3:

Before the LCD backlight goes out from step 2, press the control key again once a second to scroll through the different safety regulations showing on the screen will constantly change.

For example, if you choose the safety regulation for the Netherlands, press the control key until the LCD display shows "NL NEN50438" as below:

NL NEN50438
Pac= 0.0 W

Wait about 10 seconds. When the LCD backlight has turned off, the safety regulation setting is complete.

Comment:

- 1 If the display shows "DEFAULT", keep on pressing the control button until the display shows the desired safety regulation.
- 2 To set up other safety regulations refer to the example of setting the Netherlands

NOTICE

Risk of injury due to incorrect installation

- We strongly recommend carrying out preliminary checks before commissioning to avoid possible damage to the device caused by faulty installation.

8.1 Electrical checks

Carry out the main electrical tests as follows:

- ① Check the PE connection with a multimeter: make sure that the inverter's exposed metal surface has a ground connection.

DANGER

Danger to life due to the presence of DC voltage

- Only touch the insulation of the PV array cables.
- Do not touch parts of the sub-structure and frame of PV array.
- Wear personal protective equipment such as insulating gloves.

- ② Check the DC voltage values: check that the DC voltage of the strings does not exceed the permitted limits. Refer to the Section 2.1 "Intended use" about designing the PV system for the maximum allowed DC voltage.
- ③ Check the polarity of the DC voltage: make sure the DC voltage has the correct polarity.
- ④ Check the PV array's insulation to ground with a multimeter: make sure that the insulation resistance to ground is greater than 1 MOhm.

 **DANGER**

Danger to life due to the presence of AC voltage

- Only touch the insulation of the AC cables.
- Wear personal protective equipment such as insulating gloves.

- ⑤ Check the grid voltage: check that the grid voltage at the point of connection of the inverter complies with the permitted value.

8.2 Mechanical checks

Carry out the main mechanical checks to ensure the inverter is waterproof:

- ① Make sure the inverter has been correctly mounted with wall bracket.
- ② Make sure the cover has been correctly mounted.
- ③ Make sure the communication and AC cable gland has been mounted properly and adequately locked.

8.3 Start-Up

After finishing the electrical and mechanical checks, switch on the miniature circuit-breaker and DC-switch in turn. Once the DC input voltage is sufficiently high and the grid-connection conditions are met, the inverter will start operation automatically. Usually, there are three states during operation:

Waiting: When the initial voltage of the strings is greater than the minimum DC input voltage but lower than the start-up DC input voltage, the inverter is waiting for sufficient DC input voltage and cannot feed power into the grid.

Checking: When the initial voltage of the strings exceeds the start-up DC input voltage, the inverter will check feeding conditions at once. If there is anything wrong during checking, the inverter will switch to the "Fault" mode.

Normal: After checking, the inverter will switch to "Normal" state and feed power into the grid.

During periods of low radiation, the inverter may continuously start up and shut down. This is due to insufficient power generated by the PV array.

If this fault occurs often, please call service.



Quick Troubleshooting

If the inverter is in "Fault" mode, refer to Section 11 "Troubleshooting".

9 Disconnecting the Inverter from Voltage Sources

Prior to performing any work on the inverter, disconnect it from all voltage sources as described in this section. Always adhere strictly to the prescribed sequence.

NOTICE

Destruction of the measuring device due to overvoltage

- Only use measuring devices with a DC input voltage range of 600 V or higher.

Procedure:

1. Disconnect the miniature circuit-breaker and secure against reconnection.
2. Disconnect the DC switch and secure against reconnection.
3. Use a current clamp meter to ensure that no current is present in the DC cables.
4. Release and remove all DC connectors. Insert a flat-blade screwdriver or an angled screwdriver (blade width: 3.5 mm) into one of the slide slots and pull the DC connectors out downwards. Do not pull on the cable.

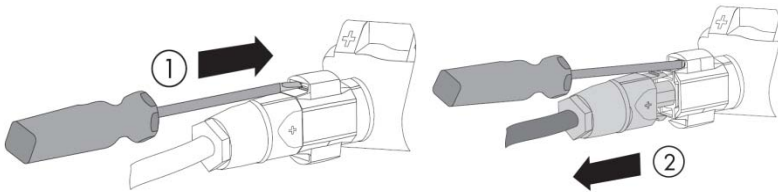

5. Ensure that no voltage is present at the DC inputs of the inverter.

⚠ DANGER

Danger to life due to high voltages

The capacitors in the inverter take 5 minutes to discharge.

- Wait 5 minutes before opening the cover.

6. Loosen the screws of the cover using a screwdriver (T25) and remove the cover.

NOTICE

Damage to the inverter due to electrostatic discharge

·Touching electronic components can cause damage to or destroy the inverter through electrostatic discharge.

7. Use a suitable measuring device to check that no voltage is present at the AC screw terminal blocks between L and N and L and PE.
8. Unscrew the screws of the screw terminal blocks and the swivel nut of the M20 cable gland, remove the AC cable .
9. Secure the cover (torque: 2.2 - 2.5 Nm) using a screwdriver (T25).

10 Technical Data

10.1 DC input data

Input (DC)	Zevelution 1000S	Zevelution 1500S	Zevelution 2000S	Zevelution 3000S
Max. PV array power (STC)	1430Wp	2140Wp	2860Wp	3900Wp
DC convertible power (@ $\cos\phi=1$)	1150W	1750W	2350W	3150W
Max. input voltage	500V			600V
MPP voltage range /	70-450V			70-520V
Rated input voltage	360V			
Min. start voltage	80V			
Min. feed-in power	6W			
Max. input current per MPPT	11A			
Number of MPPTs	1			
Number of independent MPP inputs	1			

10.2 AC output data

Output (AC)	Zevelution 1000S	Zevelution 1500S	Zevelution 2000S	Zevelution 3000S
Rated active power	1000W	1500W	2000W	3000W
Max. apparent AC power	1100VA	1650VA	2200VA	3000 VA
Nominal AC voltage / range	220V,230V,240V / 180V-280V			
AC power frequency / range	50,60 / ±5Hz			
Rated power frequency / rated grid voltage	50Hz / 230V			
Max. output current	5.5A	7.5A	10A	15A
Power factor (@rated power)	1			
Adjustable displacement power factor(only for VDE4105)	0.95 _{inductive} ... 0.95 _{capacitive}			
Adjustable displacement power factor	0.8 _{inductive} ... 0.8 _{capacitive}			
Feed-in phases / connection phases	1 / 1			
Harmonic distortion (THD) at rated output	< 3%			

10.3 General data

General data	Zeverlution 1000S	Zeverlution 1500S	Zeverlution 2000S	Zeverlution 3000S
Communication interfaces: RS485 / RS485 ¹) & Ethernet & WIFI & a.RJ45 ²)(DRED)	● / ○			
Display	16 x 2 characters			
Dimensions (W x H x D)	346 x 346 x 132mm			346 x 346 x 146mm
Weight	6.5Kg			6.8Kg
Cooling concept	convection			
Noise emission (typical)	< 15 dB(A)@1m			
Installation	indoor & outdoor			
Mounting information	wall mounting bracket			
DC connection technology	SUNCLIX			
AC connection technology	screw clamp terminal			
Operating temperature range	-25°C...+60°C / -13°F ...+140°F			
Relative humidity (non-condensing)	0% ... 100%			
Max. operating altitude	4000m(>3000m derating)			
Degree of protection (according to IEC 60529)	IP65			
Climatic category (according to IEC 60721-3-4)	4K4H			
Topology	H5			
Self-consumption (night)	<1W			
Radio technology	WLAN 802.11 b / g / n			

Radio spectrum	24 GHz
Standby power	<6W

●—Standard ○—Optional —N/A

1) for O-export with smart meter 2) only functional in AU & NZL

10.4 Safety regulations

Protective devices	Zeverlution 10005	Zeverlution 15005	Zeverlution 20005	Zeverlution 30005
DC isolator	○			
PV iso / Grid monitoring	● / ●			
DC reverse polarity protection / AC short- circuit current capability	● / ●			
Residual current monitoring(GFCI) function	●			
Earth Fault Alarm	cloud based, audible and visible(AU)			
Protection class (according to IEC 62103) / overvoltage category (according to IEC 60664-1)	I / II(DC), III(AC)			
Internal overvoltage protection	Integrated			
DC feed-in monitoring	Integrated			
Islanding protection	Integrated			
EMC immunity	EN61000-6-1, EN61000-6-2			
EMC emission	EN61000-6-3, EN61000-6-4			
Utility interference	EN61000-3-2, EN61000-3-3			

●—Standard ○—Optional —N/A



If you use the standard VDE-AR-N 4105, please refer to the information below !

- If a central NS protection device is used, then the value of the voltage protection $U > 1.1U_n$ in the integrated NS protection can be changed with a password.
- The displacement factor $\cos(\phi)$ value is not necessary to be adjustable if the power generation system $\Sigma S_{max} \leq 3.68 \text{ KVA}$ and was set to 1 as default in the embedded inverter software. However, if the power generation system is such that $3.68 \text{ KVA} < \Sigma S_{max} \leq 13.8 \text{ KVA}$, the standard $\cos(\phi)$ characteristic curve defined in VDE-AR-N 4105 shall be applied through the ZeverCom/ZeverManager.

10.5 Efficiency

The operating efficiency is shown for the three input voltages (V_{mppmax} , $V_{dc,r}$ and V_{mppmin}) graphically. In all cases the efficiency refers to the standardized power output ($P_{ac}/P_{ac,r}$). (according to EN 50524 (VDE 0126-13): 2008-10, cl. 4.5.3).

Notes: Values are based on rated grid voltage, $\cos(\phi) = 1$ and an ambient temperature of 25°C.

Efficiency curve Zeverlution 1000S

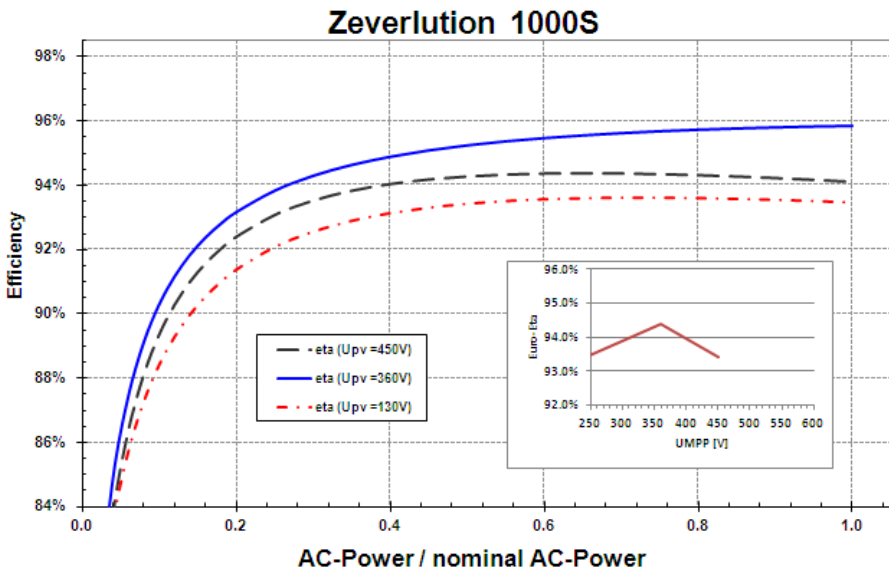

Efficiency	
Max. efficiency / European weighted efficiency	95.8% / 94.4%
MPPT efficiency	99.50%

Efficiency curve Zevelution 1500S

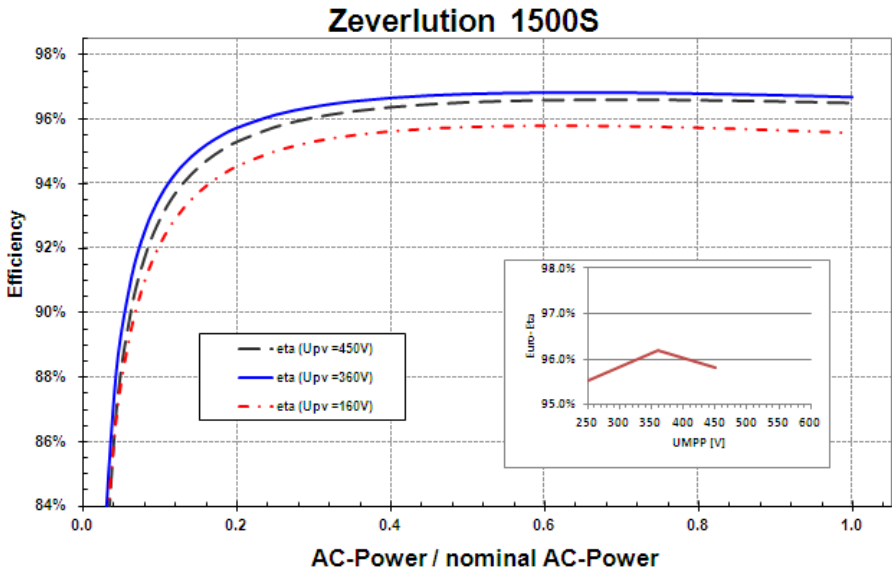

Efficiency	
Max. efficiency / European weighted efficiency	97.1% / 96.4%
MPPT efficiency	99.50%

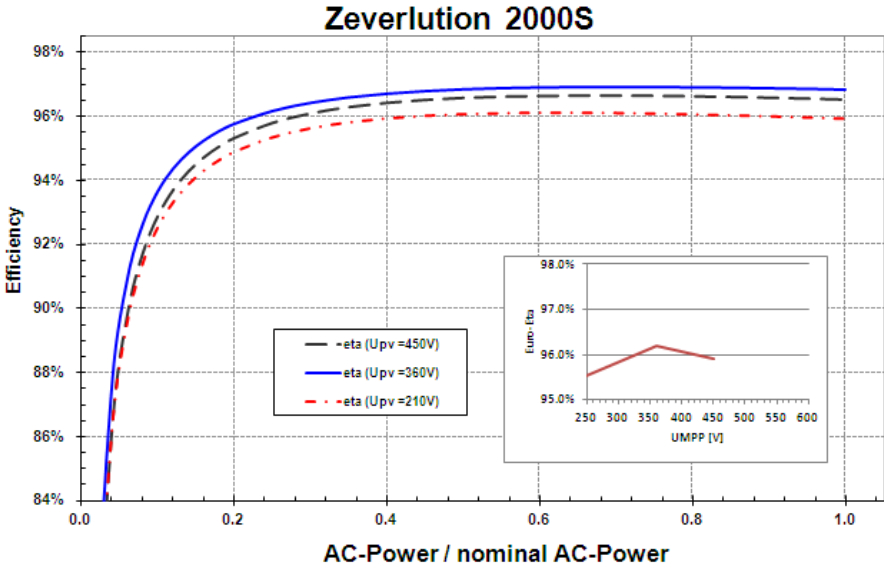

Efficiency	
Max. efficiency / European weighted efficiency	97.2% / 96.6%
MPPT efficiency	99.50%

Efficiency curve Zevelution 3000S

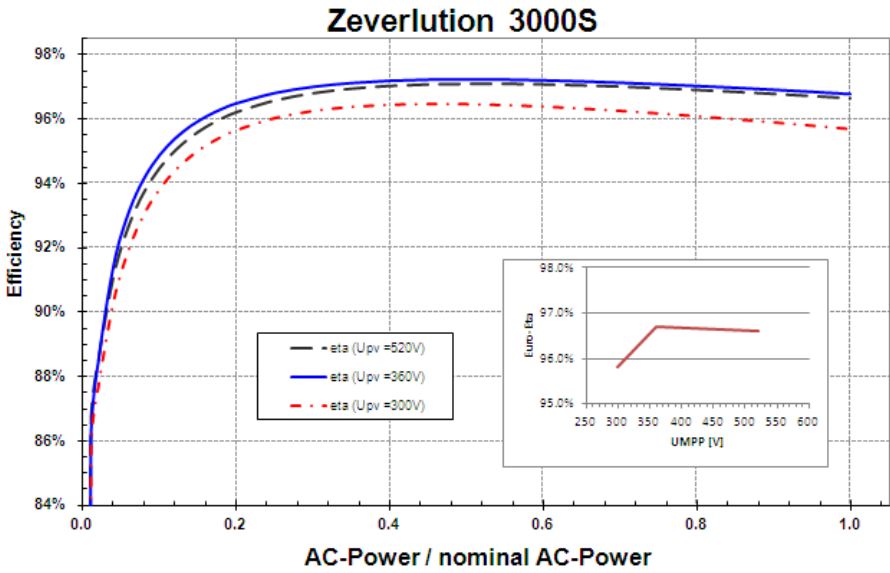

Efficiency	
Max. efficiency / European weighted efficiency	97.4% / 97%
MPPT efficiency	99.50%

10.6 Power reduction

In order to ensure inverter operation under safe conditions, the device may automatically decrease power output.

Power reduction depends on many operating parameters including ambient temperature and input voltage, grid voltage, grid frequency and power available from the PV modules. This device can decrease power output during certain periods of the day according to these parameters.

Notes: Values are based on rated grid voltage and $\cos(\phi) = 1$.

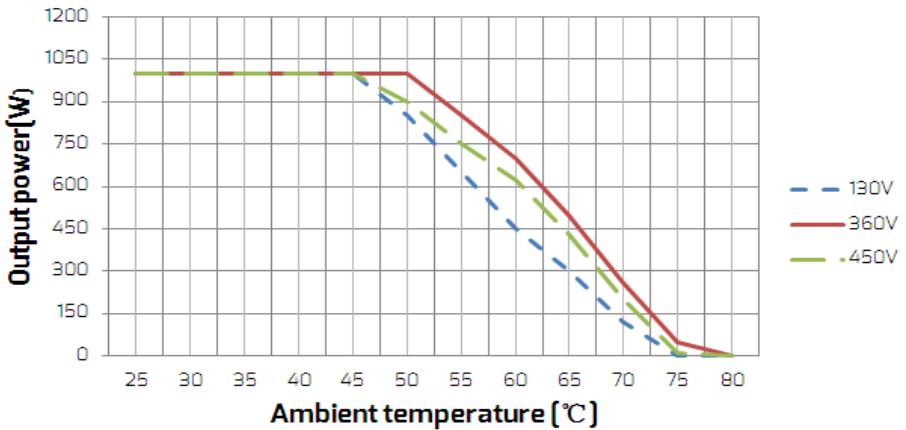

Power reduction with increased ambient temperature (Zeverlution 1000S)

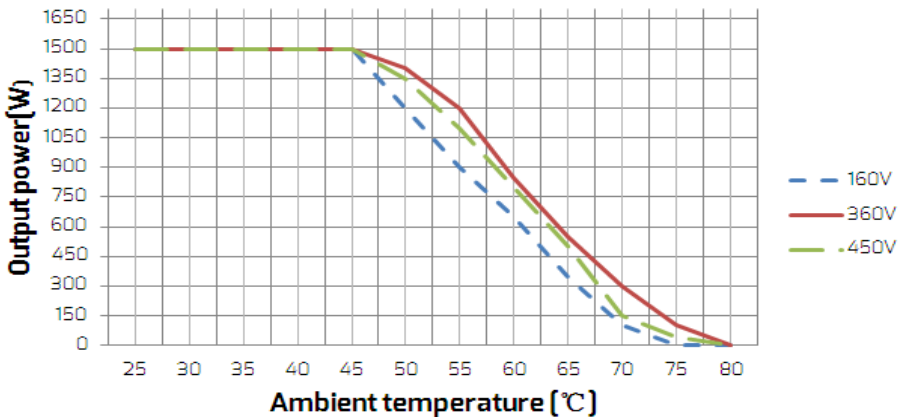

Power reduction with increased ambient temperature (Zeverlution 1500S)

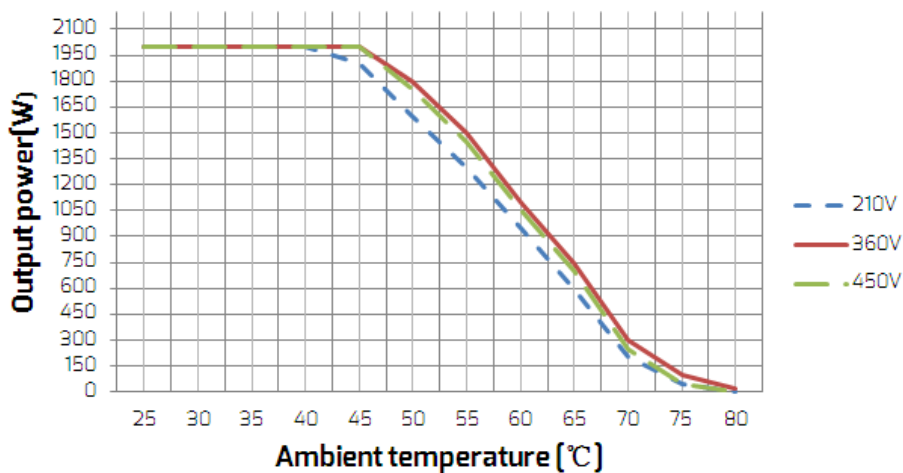

Power reduction with increased ambient temperature (Zeverlution 2000S)

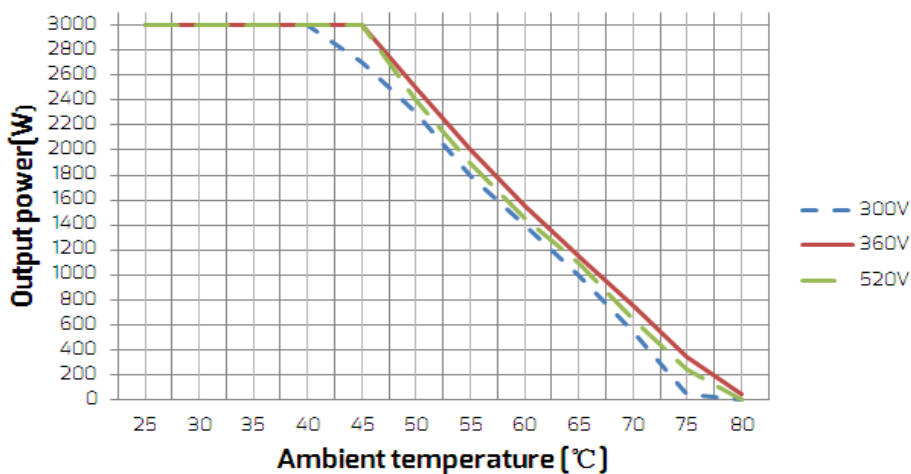

Power reduction with increased ambient temperature (Zeverlution 3000S)



The power reduction curve is tested at normal air pressure! Different air pressure condition will cause different test result

10.7 Tools and torque

Tools and torque required for installation and electrical connections.

Tools, model		Object	Torque
Torque screwdriver, T25		Screws for the cover	2.2-2.5Nm
		Screw for second protective grounding connection	
		Screws for connecting the inverter and wall bracket	
Flat-head screwdriver, blade with 1×5.5mm		Screw terminal block for AC cable	1.2-1.5Nm
Flat-head screwdriver, blade with 3.5mm		Sunclix DC connector	
		Antenna	Hand-tight
Socket wrench	Open end of 30	Swivel nut of M25 cable gland	Hand-tight
	Open end of 24	Swivel nut of M20 cable gland	Hand-tight
	Open end of 15	Swivel nut of sunclix connector	2.0Nm
	Open end of 10	Hex bolts for wall bracket	Hand-tight
Wire stripper		Peel cable jackets	
Crimping tools		Crimp power cables	
Hammer drill, drill bit of Ø10		Drill holes on the wall	
Rubber mallet		Hammer wall plugs into holes	
Cable cutter		Cut power cables	
Multimeter		Check electrical connection	
Marker		Mark the positions of drill holes	
ESD glove		Wear ESD glove when opening the inverter	
Safety goggle		Wear safety goggle during drilling holes.	
Anti-dust respirator		Wear anti-dust respirator during drilling holes.	

11 Troubleshooting

When the PV system does not operate normally, we recommend the following solutions for quick troubleshooting. If an error occurs, the red LED will light up. The corresponding causes are described in Section 7.2 "Display Messages". The corresponding corrective measures are as follows:

Object	Error code	Corrective measures
Presumable Fault	6	<ul style="list-style-type: none">• Check the open-circuit voltages of the strings and make sure it is below the maximum DC input voltage of the inverter.• If the input voltage is within the permitted range and the fault still occurs, it might be that the internal circuit has broken. Contact the service.
	33	<ul style="list-style-type: none">• Check the grid frequency and observe how often major fluctuations occur. If this fault is caused by frequent fluctuations, try to modify the operating parameters after informing the grid operator first.
	34	<ul style="list-style-type: none">• Check the grid voltage and grid connection on inverter.• Check the grid voltage at the point of connection of inverter. If the grid voltage is outside the permissible range due to local grid conditions, try to modify the values of the monitored operational limits after informing the electric utility company first. If the grid voltage lies within the permitted range and this fault still occurs, please call service.
	35	<ul style="list-style-type: none">• Check the fuse and the triggering of the circuit breaker in the distribution box.• Check the grid voltage, grid usability.• Check the AC cable, grid connection on the inverter. If this fault is still being shown, contact the service.

Presumable Fault	36	<ul style="list-style-type: none"> • Make sure the grounding connection of the inverter is reliable. • Make a visual inspection of all PV cables and modules. If this fault is still shown, contact the service.
	37	<ul style="list-style-type: none"> • Check the open-circuit voltages of the strings and make sure it is below the maximum DC input voltage of the inverter. <p>If the input voltage lies within the permitted range and the fault still occurs, please call service.</p>
	38	<ul style="list-style-type: none"> • Check the PV array's insulation to ground and make sure that the insulation resistance to ground is greater than 1 MOhm. Otherwise, make a visual inspection of all PV cables and modules. • Make sure the grounding connection of the inverter is reliable. <p>If this fault occurs often, contact the service.</p>
	40	<ul style="list-style-type: none"> • Check whether the airflow to the heat sink is obstructed. • Check whether the ambient temperature around the inverter is too high.
	41, 42 43, 44 45 47	<ul style="list-style-type: none"> • Disconnect the inverter from the grid and the PV array and reconnect after 3 minutes. <p>If this fault is still being shown, contact the service.</p>
	61 62	Check the DRED device communication or operation
	Permanent Fault	1, 2,3, 4,5,6, 8,9

Contact the service if you meet other problems not in the table.

12 Maintenance

Normally, the inverter needs no maintenance or calibration. Regularly inspect the inverter and the cables for visible damage. Disconnect the inverter from all power sources before cleaning. Clean the enclosure and display with a soft cloth. Ensure the heat sink at the rear of the inverter is not covered.

12.1 Cleaning the contacts of the DC switch

Clean the contacts of the DC switch annually. Perform cleaning by cycling the switch to "1" and "0" positions 5 times. The DC switch is located at the lower left of the enclosure.

12.2 Cleaning the heat sink

CAUTION

Risk of injury due to hot heat sink

- The heat sink may exceed 70°C during operation. Do not touch the heat sink during operation.
- Wait approx. 30 minutes before cleaning until the heat sink has cooled down.
- Ground yourself before touching any component.

Clean the heat sink with compressed air or a soft brush. Do not use aggressive chemicals, cleaning solvents or strong detergents.

For proper function and long service life, ensure free air circulation around the heat sink.

13 Recycling and disposal

Dispose of the packaging and replaced parts according to the rules applicable in the country where the device is installed.

Do not dispose the Zeverlution inverter with normal domestic waste.



INFORMATION

- Do not dispose of the product together with the household waste but in accordance with the disposal regulations for electronic waste applicable at the installation site.

14 EU Declaration of Conformity

within the scope of the EU directives

- Electromagnetic compatibility 2014/30/EU (L 96/79-106, March 29, 2014) (EMC).



- Low Voltage Directive 2014/35/EU (L 96/357-374, March 29, 2014) (LVD).

- Radio Equipment Directive 2014/53/EU (L 153/62-106, May 22, 2014) (RED)

SMA New Energy Technology (Jiangsu) Co., Ltd. confirms herewith that the inverters described in this document are in compliance with the fundamental requirements and other relevant provisions of the abovementioned directives. The entire EU Declaration of Conformity can be found at www.zeversolar.com.

15 Warranty

The factory warranty card is enclosed with the package, please keep well the factory warranty card. Warranty terms and conditions can be downloaded at www.zeversolar.com/service/warranty/ if required. When the customer needs warranty service during the warranty period, the customer must provide a copy of the invoice, factory warranty card, and ensure the electrical label of the inverter is legible. If these conditions are not met, ZeverSolar has the right to refuse to provide with the relevant warranty service.

16 Contact

If you have any technical problems concerning our products, please contact zerversolar service. We require the following information in order to provide you with the necessary assistance:

- Inverter device type
- Inverter serial number
- Type and number of connected PV modules
- Error code
- Mounting location
- Installation date
- Warranty card

Service Contact

Our regional services contact information can be found at :<https://www.zeversolar.com/service/customer-interaction-center/>

SMA New Energy Technology (Jiangsu) Co., Ltd.

Tel.: +86 512 6937 0998

Fax: +86 512 6937 3159

Web: www.zeversolar.com

Factory add.: No.588 Gangxing Road, Yangzhong Jiangsu, China

Headquarters add.: Building 9, No.198 Xiangyang Road, Suzhou 215011, China

540-00136-05

REV	DATE
05	2020/07/21